

NÁVOD K OBSLUZE ZAHRADNÍHO DOMKU – D04262



VŠEOBECNÉ UPOZORNĚNÍ:

- před montáží si pečlivě pročtete tento návod a seznámte se s jednotlivými díly a postupem montáže
- jednotlivé díly opatrně vyndejte z balení, menší části jako šroubky si uložte do nějaké misky, aby se Vám neztratili
- zkontrolujte, že balení obsahuje všechny díly a díly nejsou vadné, pokud sestavíte domek z vadných dílů a on se poté poškodí, nelze na něj uplatnit záruku
- pro montáž si vyčleňte 2-3 pracovní hodiny















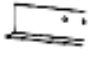
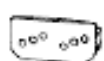



















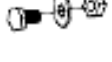

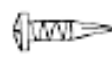







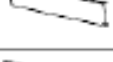

PLÁNOVÁNÍ MONTÁŽE:

- POČASÍ: domek v žádném případě nestavte za větrného či deštivého počasí, pokud několik dní předtím pršelo, dávejte pozor na mokrou a bahnitou půdu
- NÁŘADÍ: pro montáž budete potřebovat nějaké základní nářadí, které si připravte či obstarajte.

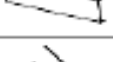
PÉČE A ÚDRŽBA:

- **ČIŠTĚNÍ:** v pravidelných intervalech čistěte povrchové plochy domku, pokud si všimnete nějakých škrábanců, je nutné je začistit.
- **STŘECHA:** během podzimu a zimy je nutné zahradní domek pravidelně zbavovat nánosů listí a sněhu, to provádějte vždy koštětem s měkkými štětinami. Vrstva těžkého sněhu může domek poškodit! Na toto poškození se nevztahuje záruka.
- **DVEŘE:** dveře udržujte v čistotě, aby nedošlo k problémům s jejich otevíráním či zavíráním. Panty sem tam promazejte olejem či silikonovým sprejem. Aby nedošlo k poškození větrem, držte dveře vždy zamčené.
- **SPOJOVACÍ MATERIÁL:** použijte všechny podložky a šroubky, které jsou součástí balení. Chcete-li zamezit vnikání vody během deště, pravidelně šroubky dotahujte.
- **VLHKOST:** umístěte domek na prodyšnou plastovou plachtu, aby se zabránilo kondenzaci.
- **UPOZORNĚNÍ!** V zahradním domku neskladujte chemikálie pro bazény. Žíravé a hořící materiály musí být bezpečně hermeticky uzavřeny.

SEZNAM DÍLŮ:

DÍL	Č.	MN.	DÍL	Č.	MN.	DÍL	Č.	MN.
	1	1		17	4		D2	1
	2	1		20	4		G2	4
	3L	1		21L	1		GB	2
	3R	1		21R	1		GC	4
	4L	1		25L	1		GD	4
	4R	1		25R	1		GF	2
	5	1		27	2		GF	2
	6	1		B1	4		F1	180
	7	1		P1	4		F2	50
	8	1		P2	4		F2	50
	9	1		P3	2		F3	8
	10L	1		P4	2		F3	8
	10R	1		P5	2		F3	8
	11	1		P6	2		F3	8
	12L	1		P7	1		F3	8
	12R	1		P7	1		F3	8
	15	2		D1	1		F3	8



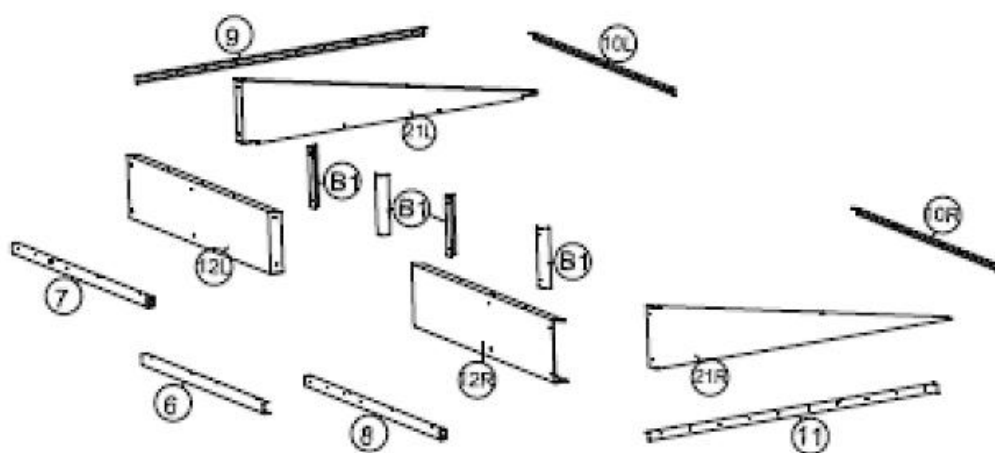
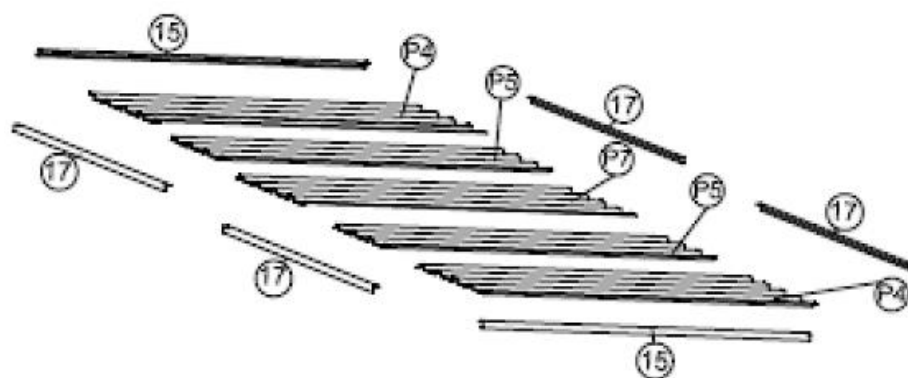

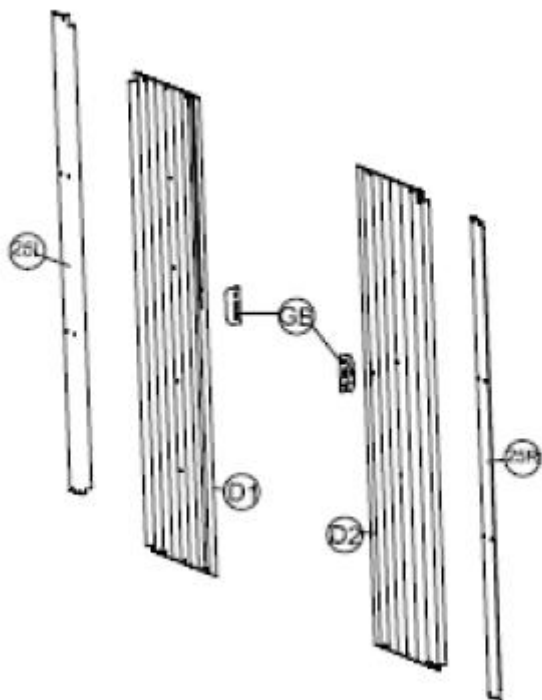
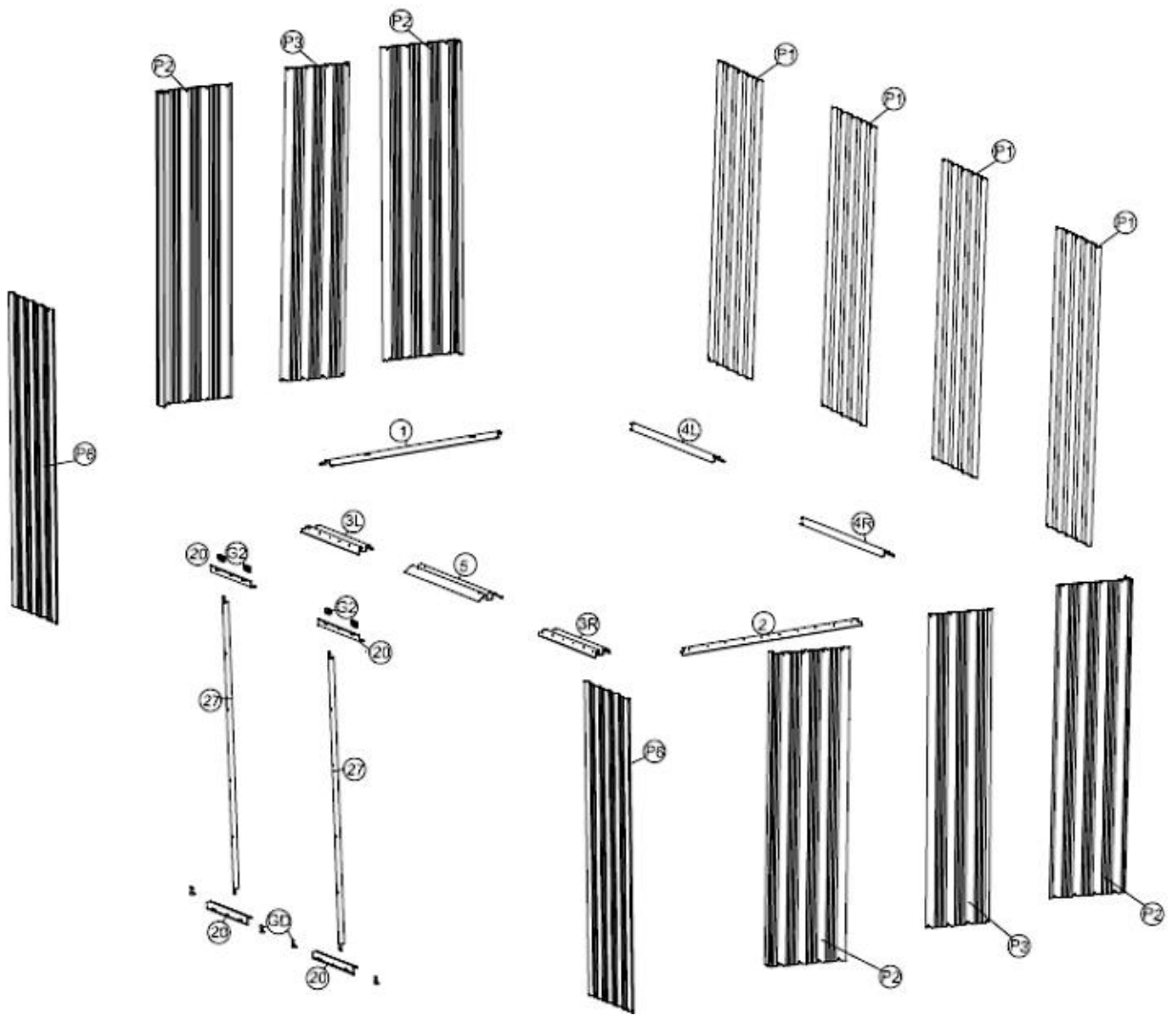

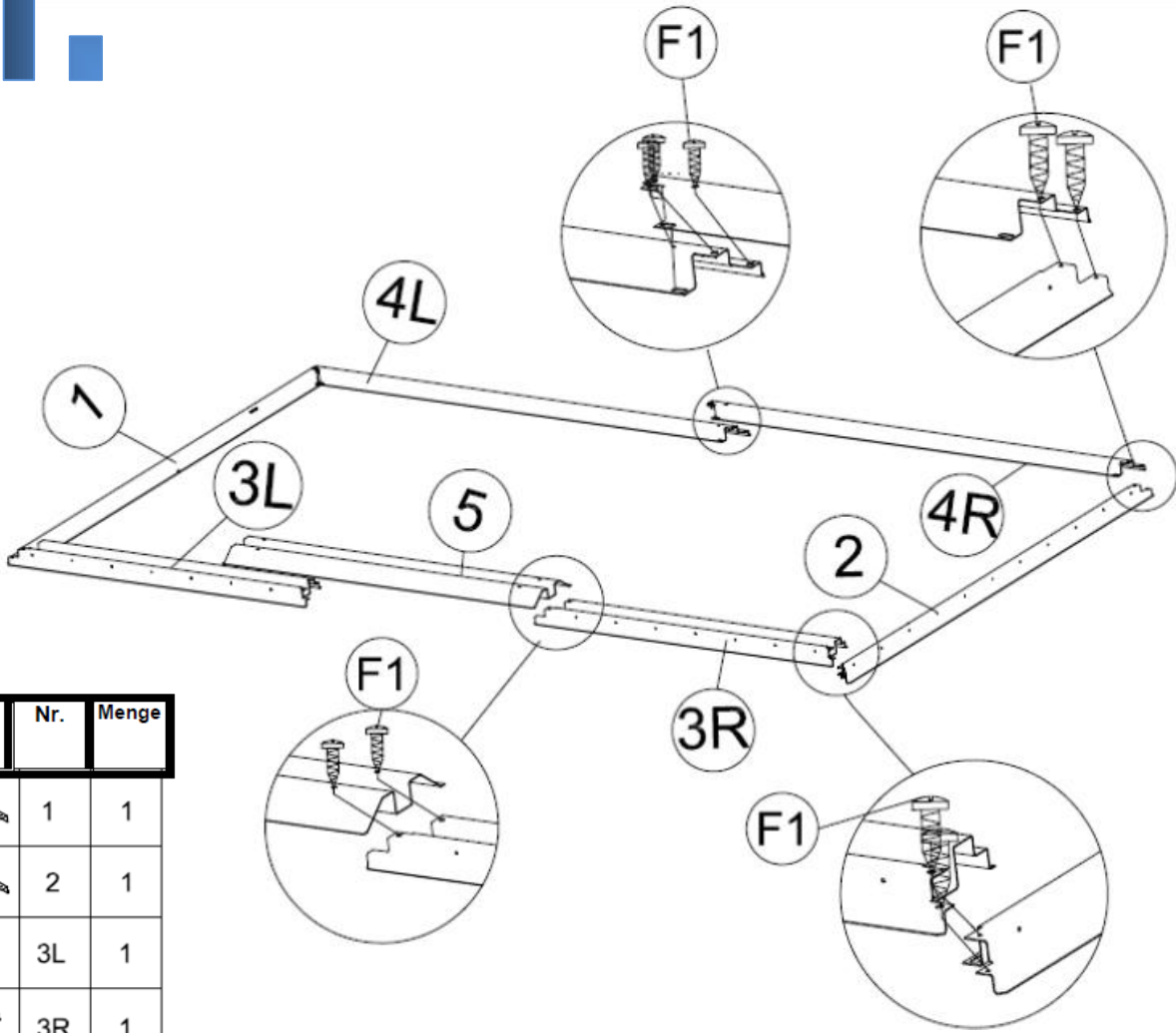

POSTUP MONTÁŽE:





1.



Teil	Nr.	Menge
	1	1
	2	1
	3L	1
	3R	1
	4L	1
	4R	1
	5	1
	F1	16



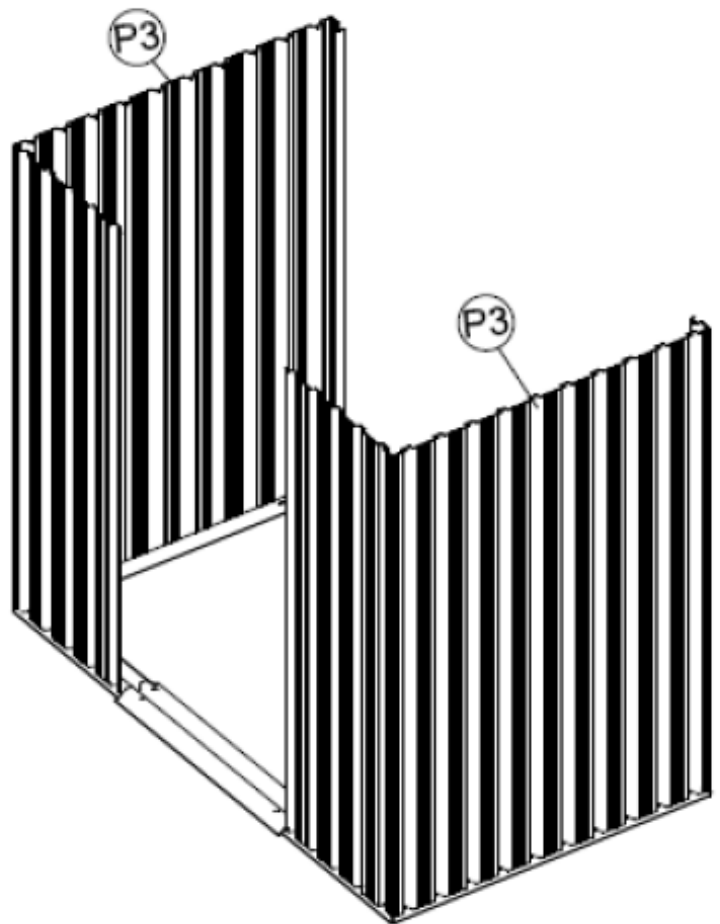
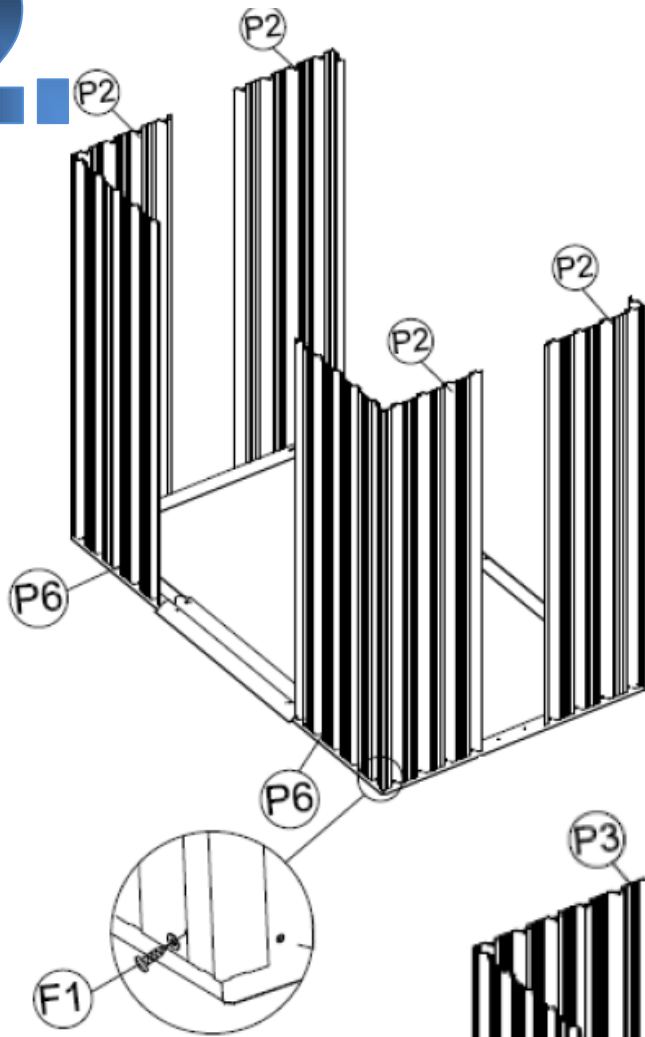



2.

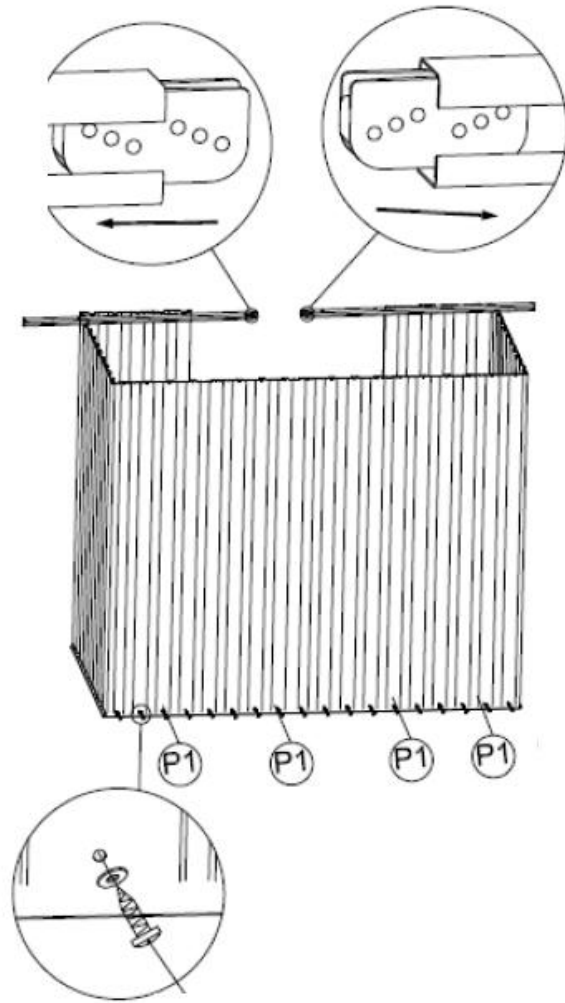

Teil	Nr.	Menge
	P2	4
	P3	2
	P6	2
	F1	30

3.



Teil	Nr.	Menge
	6	1
	7	1
	8	1
	P1	4
	G2	4
	F1	28

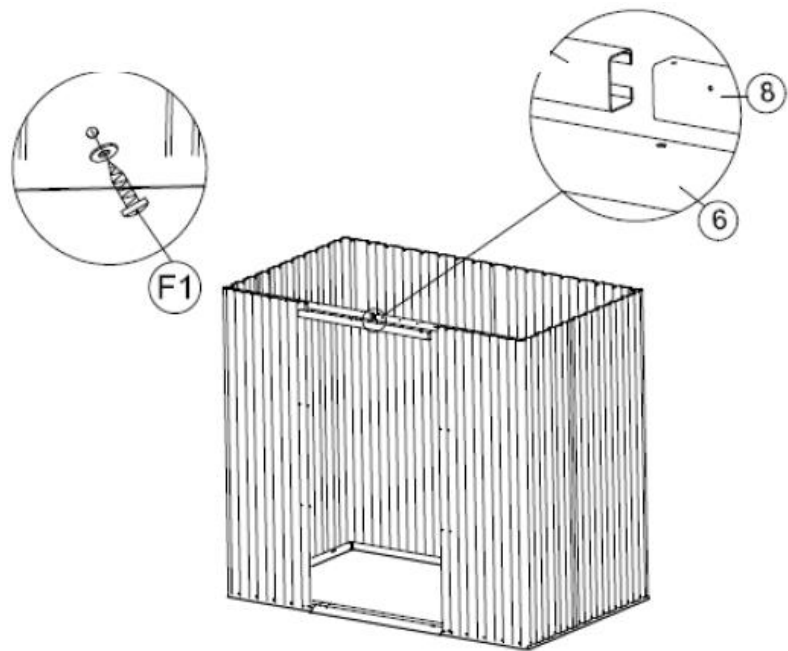



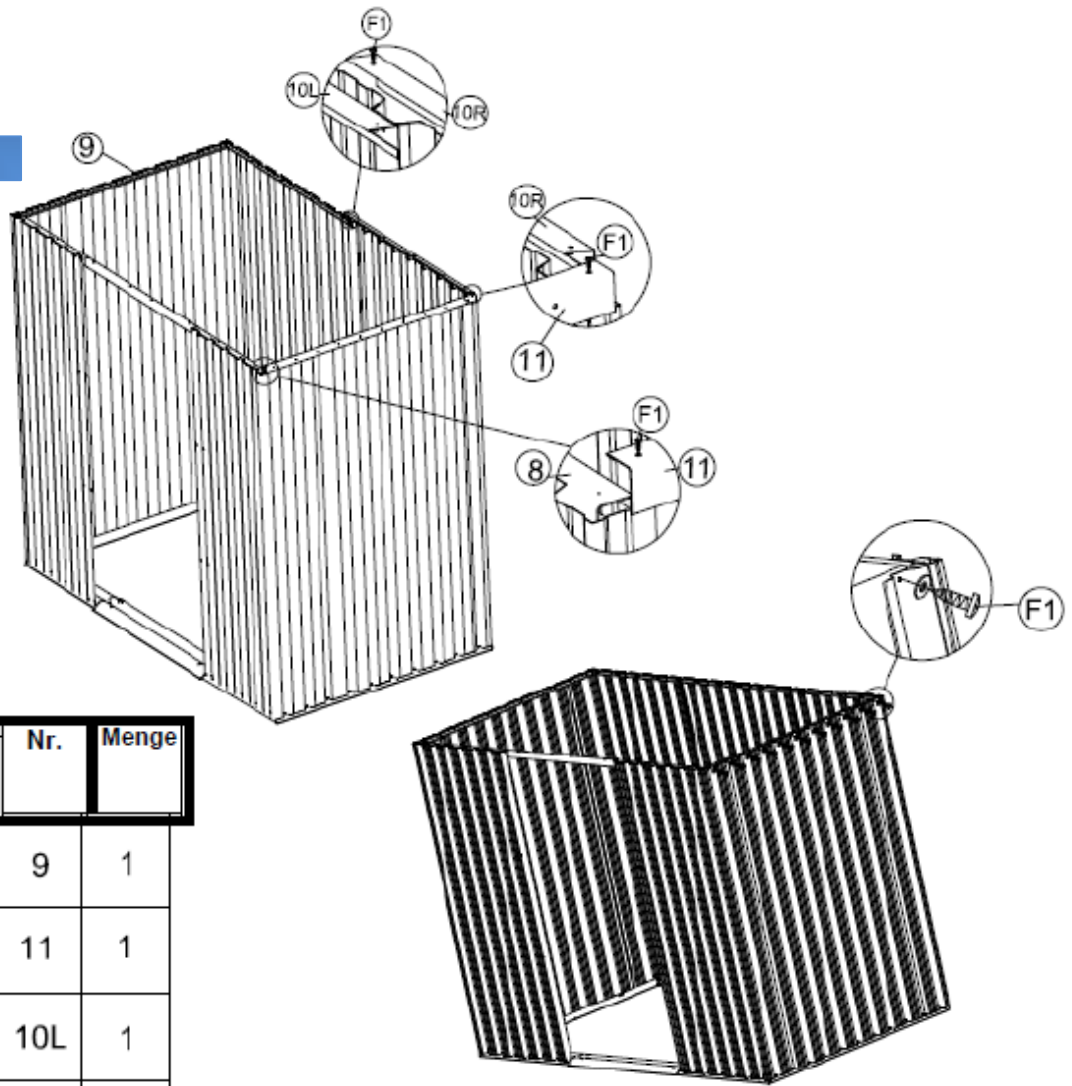

4.

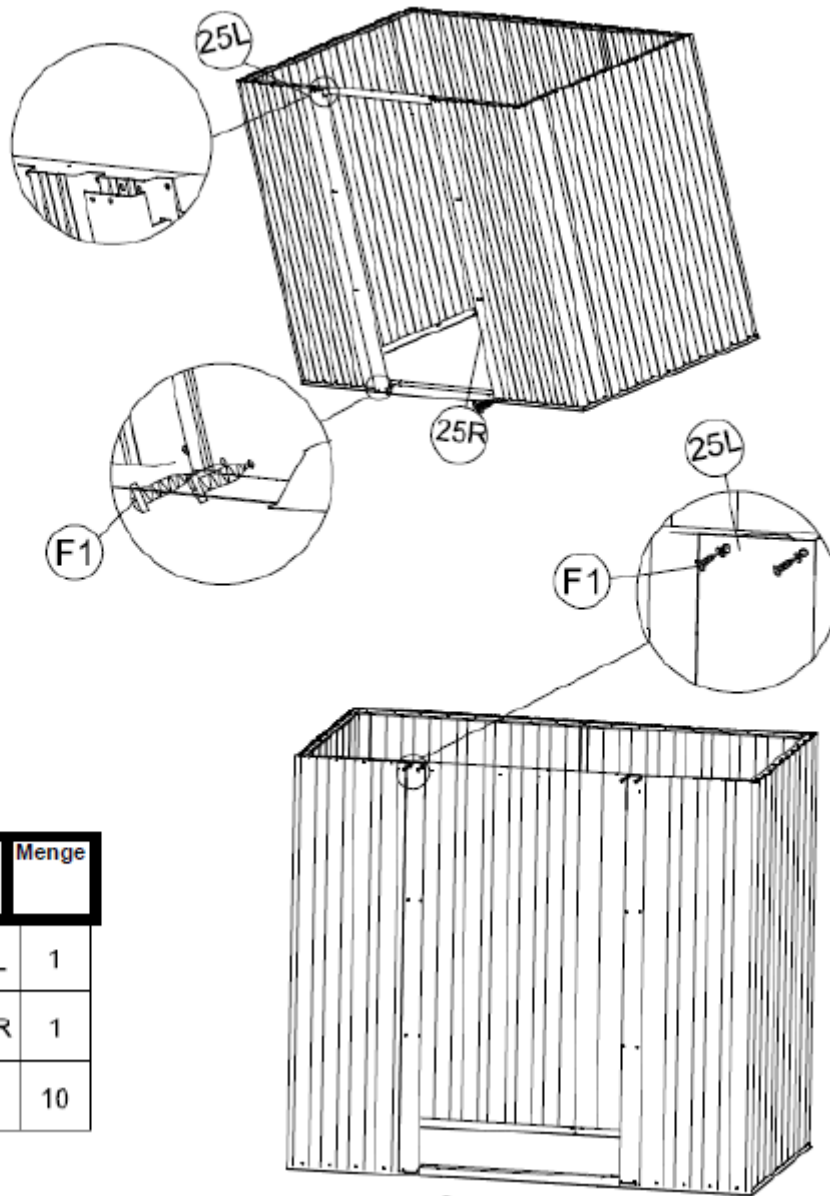

Teil	Nr.	Menge
	9	1
	11	1
	10L	1
	10R	1
	F1	39

5.



Teil	Nr.	Menge
	25L	1
	25R	1
	F1	10

6.

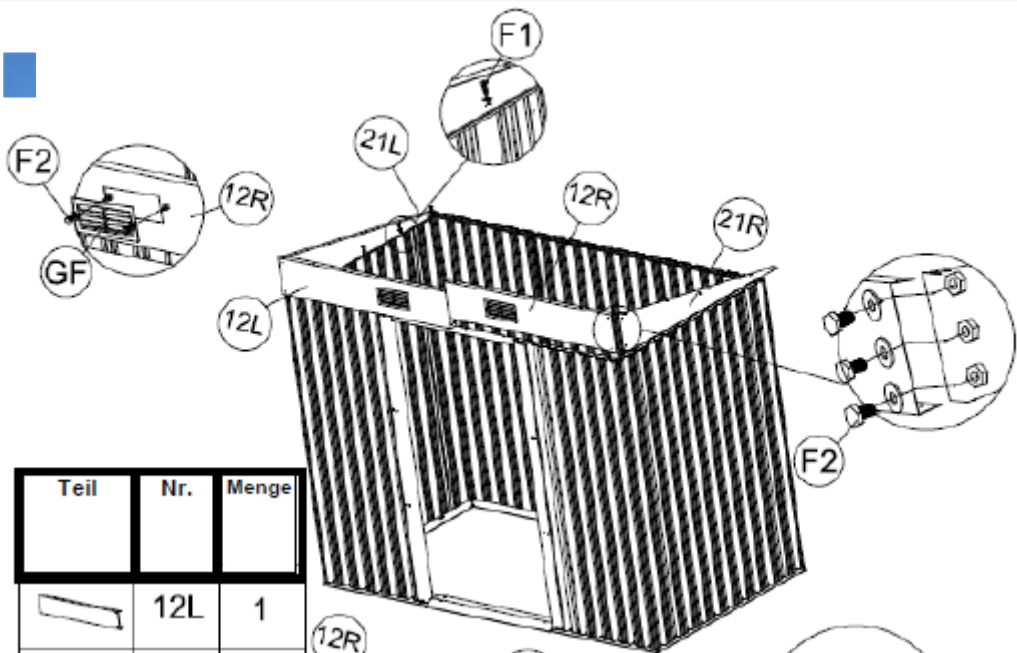



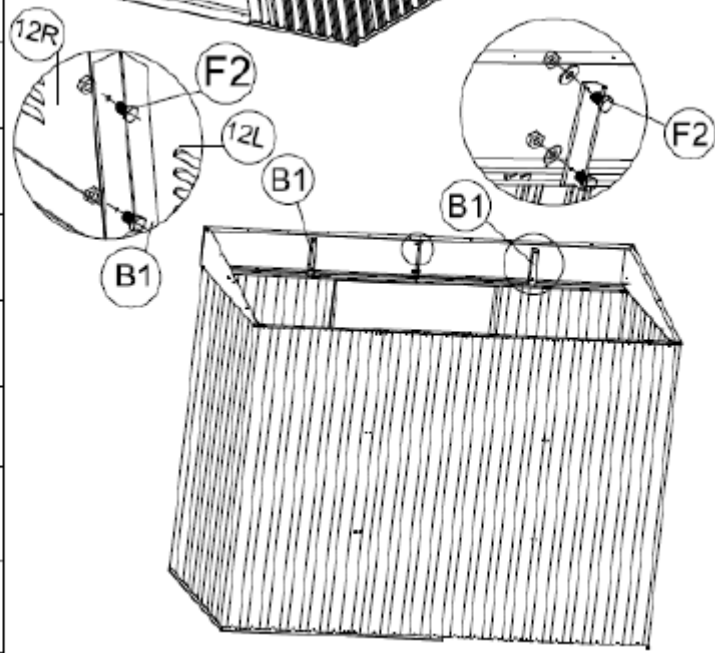

Teil	Nr.	Menge
	12L	1
	12R	1
	21L	1
	21R	1
	B1	4
	GF	2
	F1	14
	F2	16

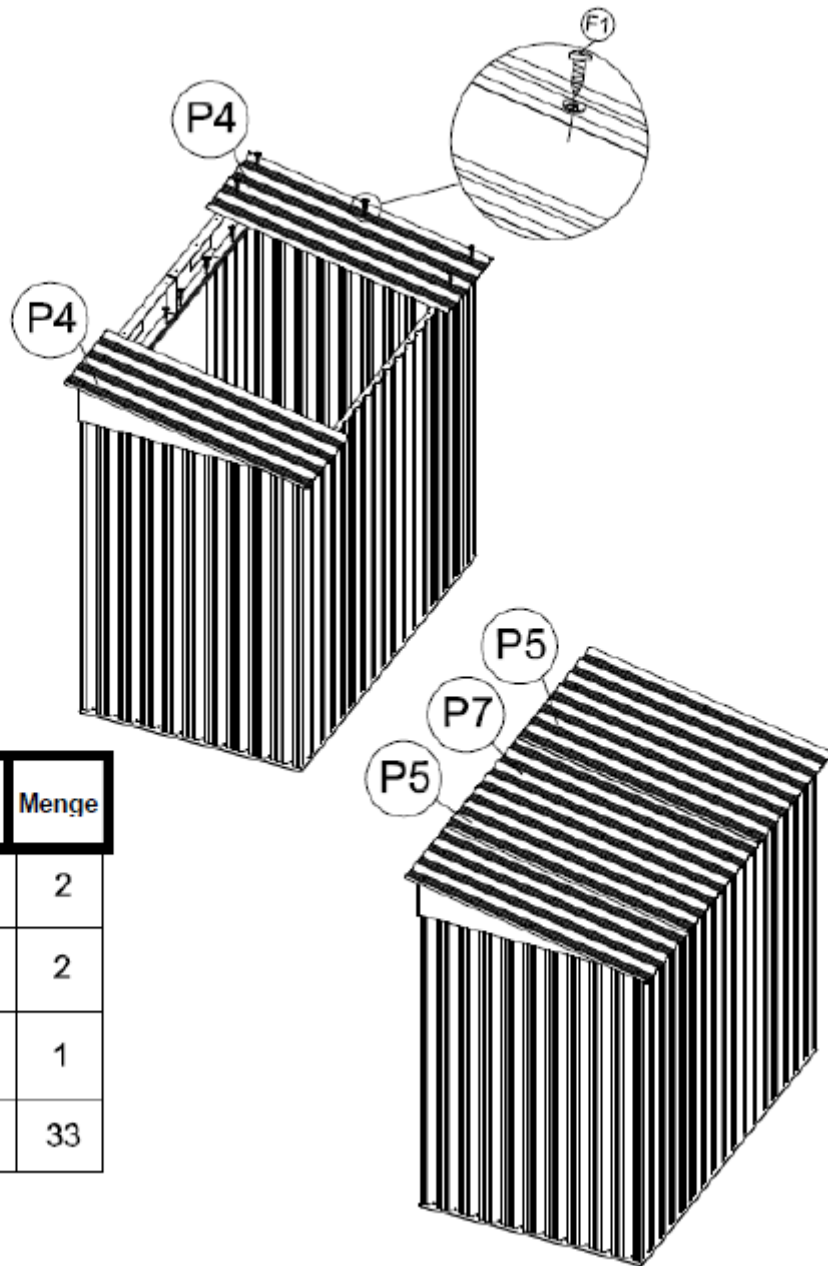





7.



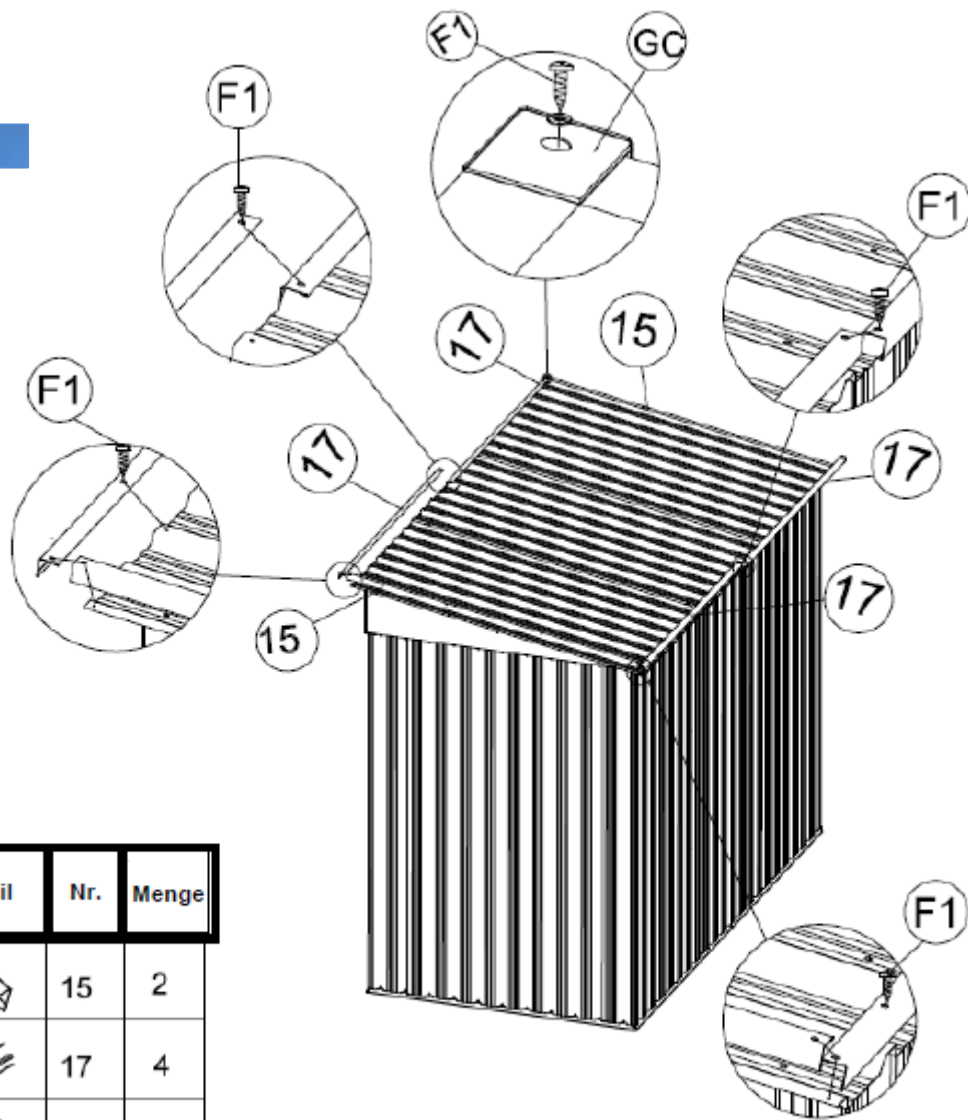





Teil	Nr.	Menge
	P4	2
	P5	2
	P7	1
	F1	33

8.



Teil	Nr.	Menge
	15	2
	17	4
	GC	4
	F1	6

9.

Teil	Nr.	Menge
	27	2
	20	4
	D1	1
	D2	1
	GD	4
	F2	16

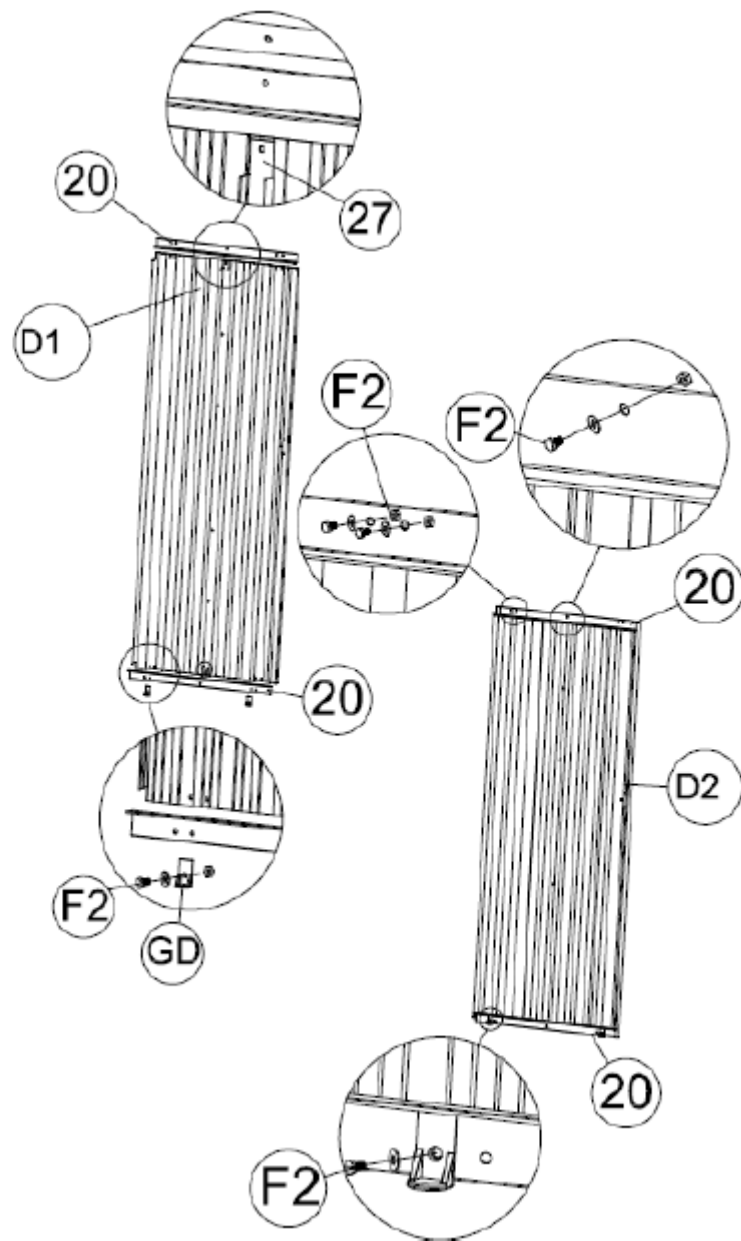

10.

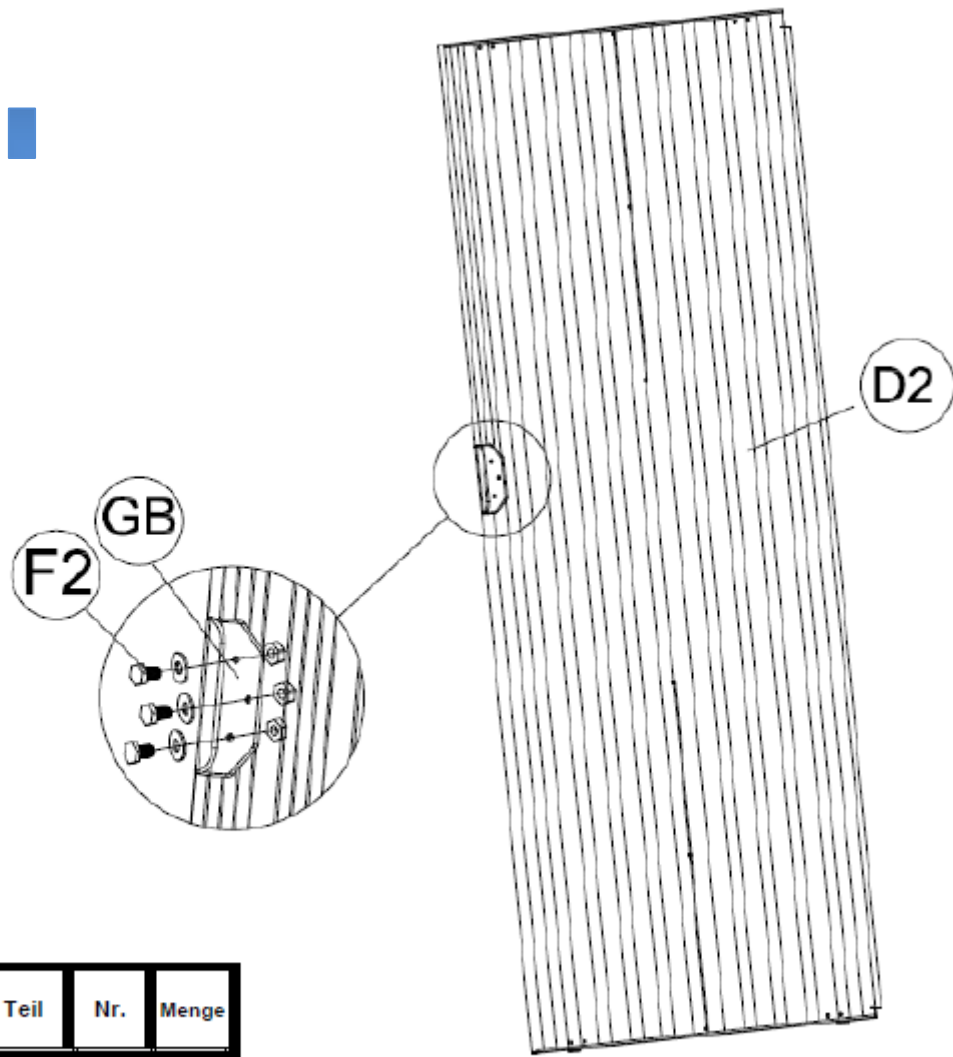

Teil	Nr.	Menge
	GB	2
	F2	6

11.

