

## NÁVOD K OBSLUZE ZAHRADNÍHO SKLENÍKU – D06136



### **VŠEOBECNÁ UPOZORNĚNÍ:**

- před montáží skleníku si pečlivě přečtete tento návod
- ujistěte se, že součástí balení jsou všechny díly, uvedené v tomto návodu
- rozřídte si obsah balení dle jednotlivých čísel dílů
- při manipulaci s díly a montáží skleníku postupujte opatrně
- nejprve sestavte polykarbonátové desky, před samotným spojováním
- tento návod si pečlivě uschovejte, pro případnou potřebu pozdějšího přečtení

### **BEZPEČNOSTNÍ UPOZORNĚNÍ:**

- při montáži doporučujeme používat pracovní rukavice
- skleník nikdy nestavte během deště nebo větru
- buďte opatrní, aby se elektrický kabel od jiných zařízení nedotkl hliníkové konstrukce
- při manipulaci s hliníkem vždy noste pracovní rukavice a pracovní ochranné brýle
- během montáže zajistěte, aby se jakékoli díly nedostaly do rukou dětí
- skleník musí být umístěn na rovné místo a zajištěn
- v průběhu stavby na skleník netlačte ani se ho nesnažte naklánět

- neumisťujte skleník na větrné místo
- nesnažte se skleník sestavovat, pokud jste unaveni, pod vlivem alkoholu nebo pokud pociťujete závrať
- pokud budete používat žebřík nebo elektrická zařízení, dodržujte pokyny výrobce
- v žádném případě neukládejte do skleníku jakékoli horké předměty, např. gril
- ujistěte se, že v zemi nejsou umístěny žádné kabely, před zapícháním kolíčků nebo jiným upevňováním skleníku

### **INFORMACE O MONTÁŽI:**

- skleník je postaven během 30 minut
- pečlivě vyberte místo kam skleník umístit, nemělo by být pod stromy, kterým visí větve nízko nad zem
- pokud chcete zabezpečit Váš skleník upevněním k základu, použijte převrtané otvory
- všechny součástky si připravte, abyste je během stavby měli po ruce
- malé části, jako šroubky, si dejte do misky, aby se Vám neztratily
- všimněte si, že dveře na pravé straně sedí v závěsu a proto je možné je otevírat pouze doprava
- ze střechy skleníku pravidelně odstraňujte spadané listí a sníh – při velké zátěži by se skleník mohl poškodit a toto poškození nelze reklamovat

### **ÚDRŽBA A OŠETŘENÍ:**

- skleník v případě potřeby omývejte pouze jemným čisticím prostředkem a poté opláchněte studenou vodou
- v žádném případě nepoužívejte agresivní čisticí prostředky s acetonem, drsné hadříky nebo houby ani jiné specializované čisticí prostředky

### **CO BUDETE KE STAVBĚ POTŘEBOVAT:**

- silikon, lopata, křížový šroubovák, metr, lepicí pásku, nůžky, kladivo, pracovní rukavice, vrtačku, vodováhu, mazivo, gumovou palici

**SEZNAM DÍLŮ:**

PART	NO.	Qty.
	D1	1
	D4	1
	D2	1
	D3	3
	W1	1
	W2	2
	W3	1
	W4	1
	4	2
	5	1
	6	1
	7	4
	16	4
	8	2
	9	2
	10R	1
	10L	1
	19	6
	20	6
	12	4
	15	1
	21	1
	13	1
	14	1
	22	8
	23	4
	17	1

PART	NO.	Qty.
	18	1
	25	2
	26	1
	B1	6
	B3	2
	B4	4
	B5	4
	B6	2
	B7	1
	T1	6
	T2	3
	S2	13
	S5	2
	S6R	2
	S6L	2
	S7R	1
	S7L	1
	S8	1
	F1	10
	F2	4
	F4	154
	F6	2
		1
		1

PC Platten	P1	3
	P2	1
	P3	4
	P4R	2
	P4L	2
	P5	1
	P6	1
	P7	1
	P8	8
	P9	7
P10	1	

## POSTUP SESTAVENÍ SKLENÍKU:





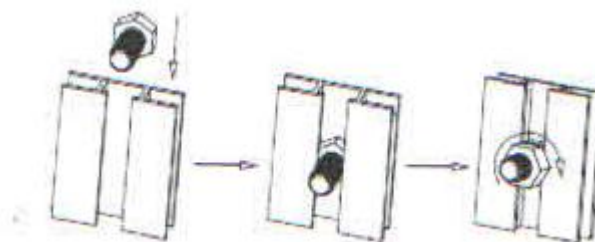

Desky jsou potaženy fólií na ochranu proti UV záření.

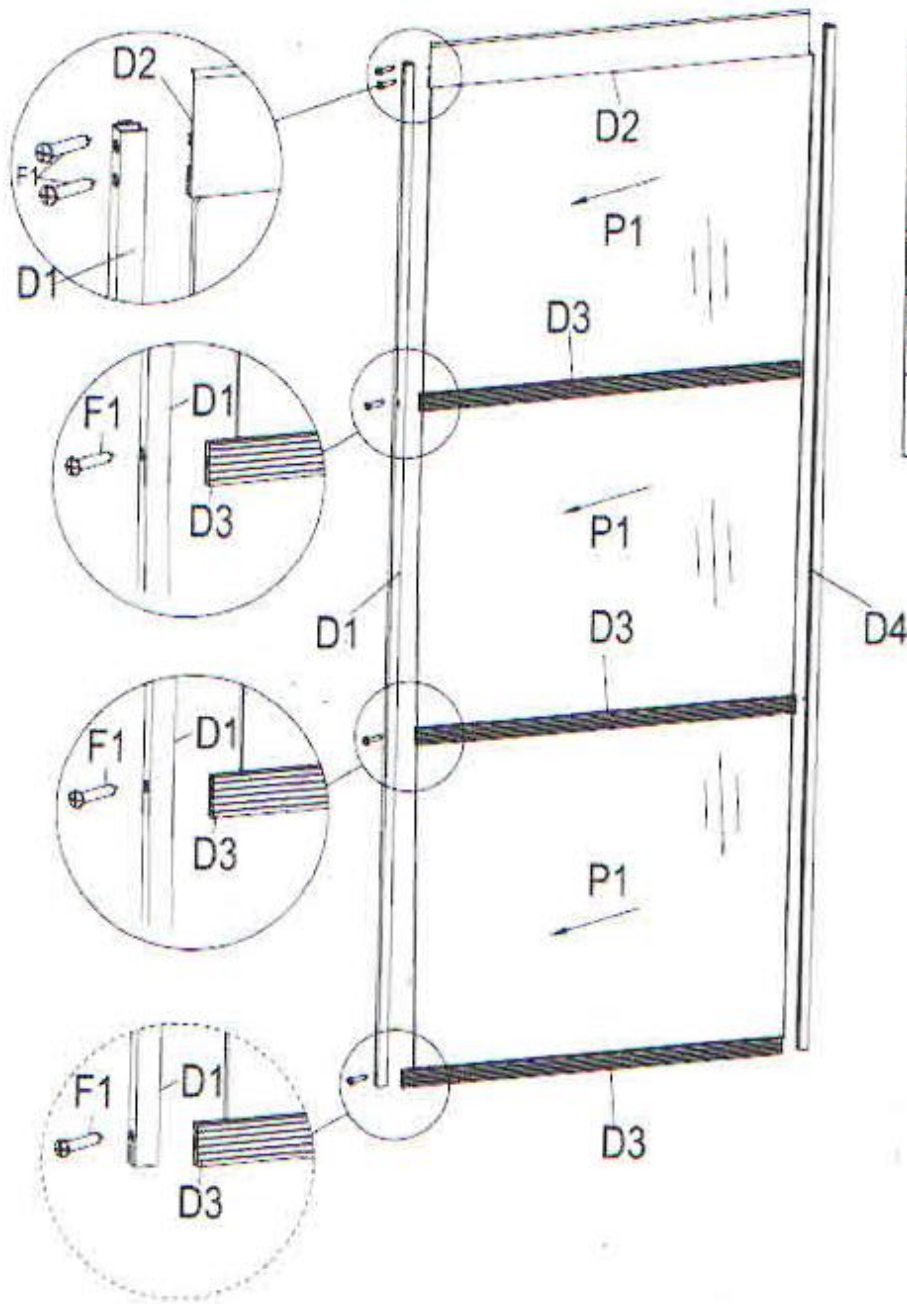
Umístěte šroub do kloubu a otočte jím po směru hodinových ručiček.





PART	NO.	Qty.
	D1	1
	D4	1
	D2	1
	D3	3
	F1	10



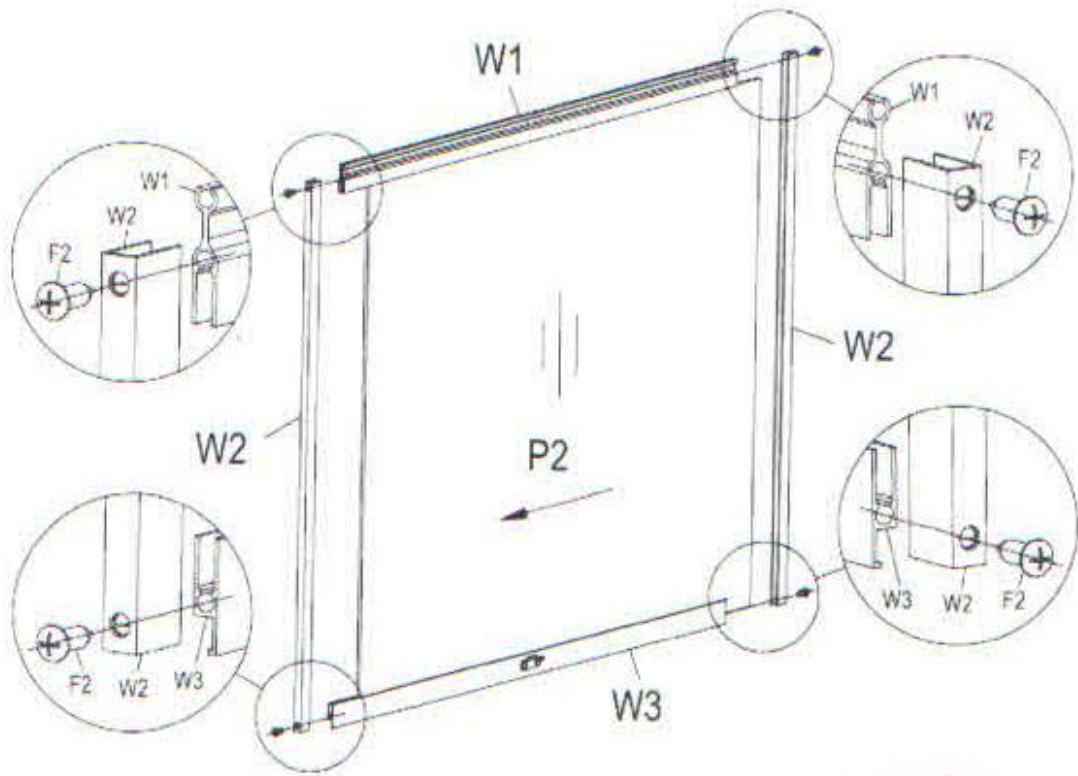



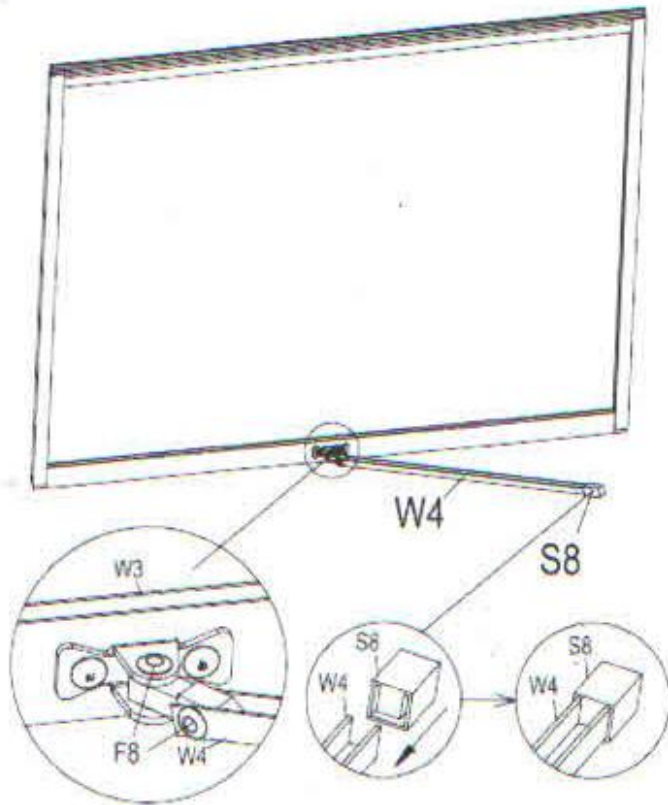

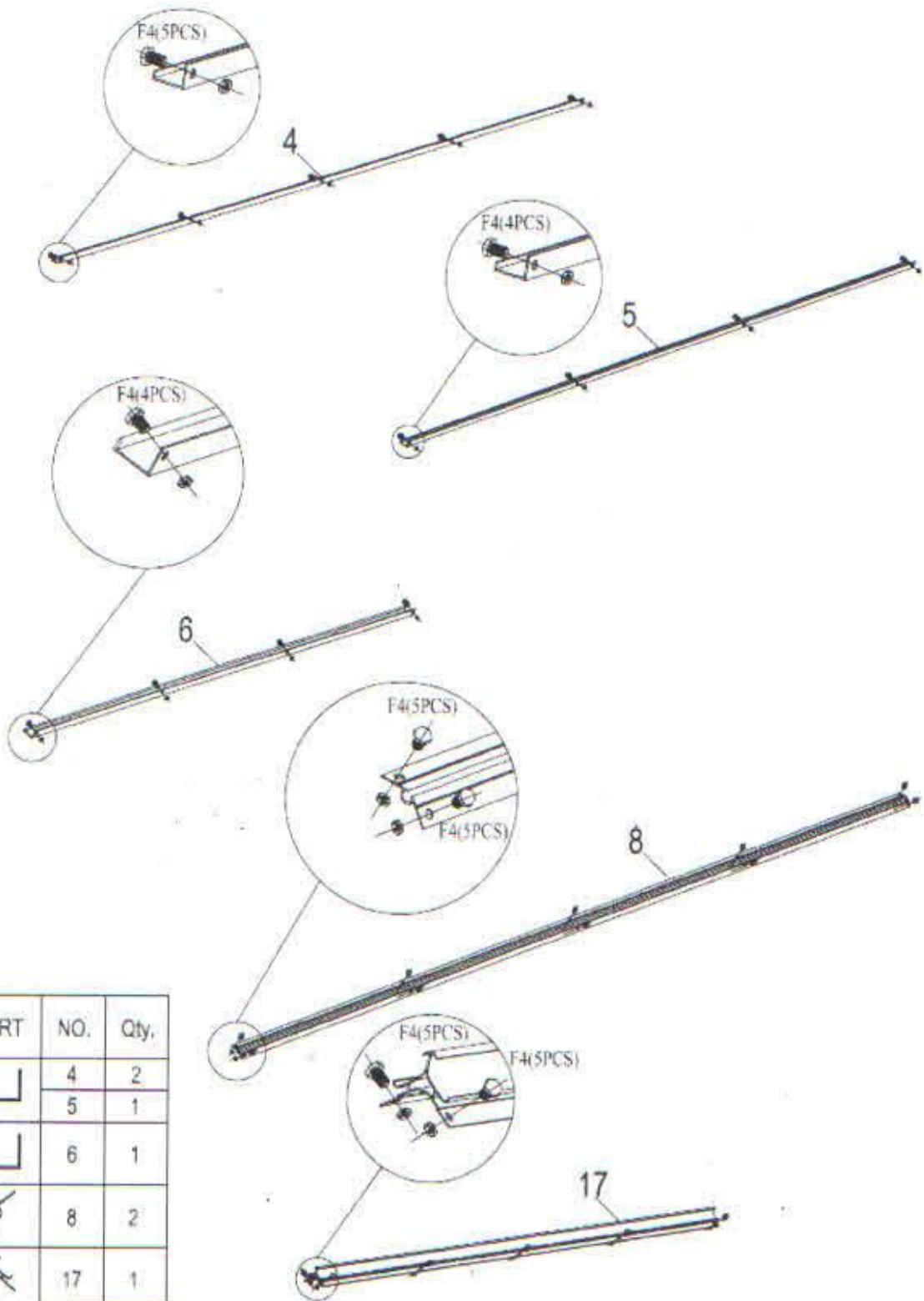
PART	NO.	Qty.
	W1	1
	W2	2
	W3	1
	W4	1
	S8	1
	F2	4
	F8	1
	F8	1





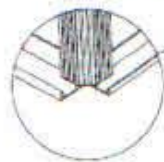
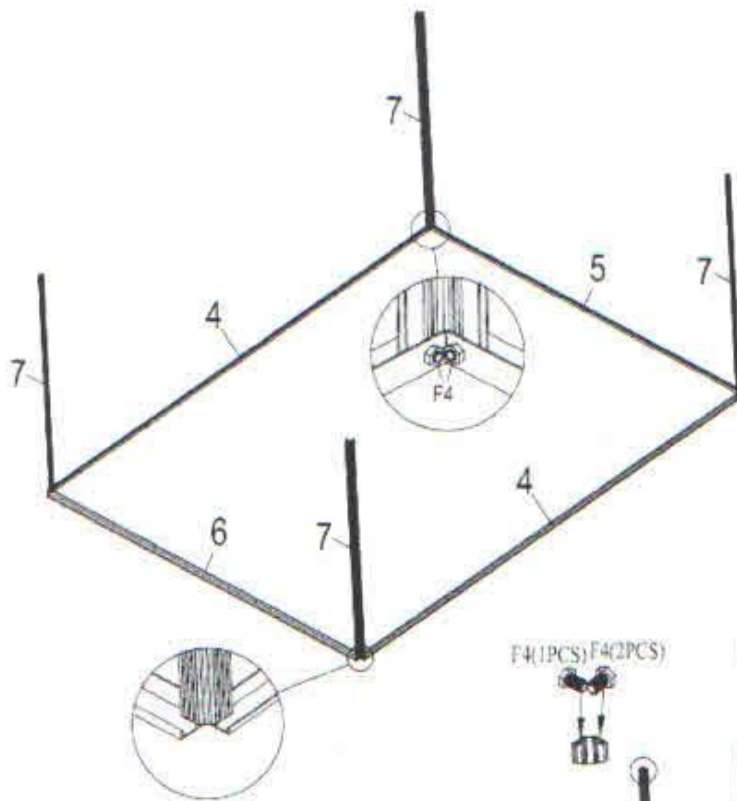

PART	NO.	Qty.
	4	2
	5	1
	6	1
	8	2
	17	1
	F4	48



F4(1PCS) F4(2PCS)

F4(1PCS) 10R and 10L



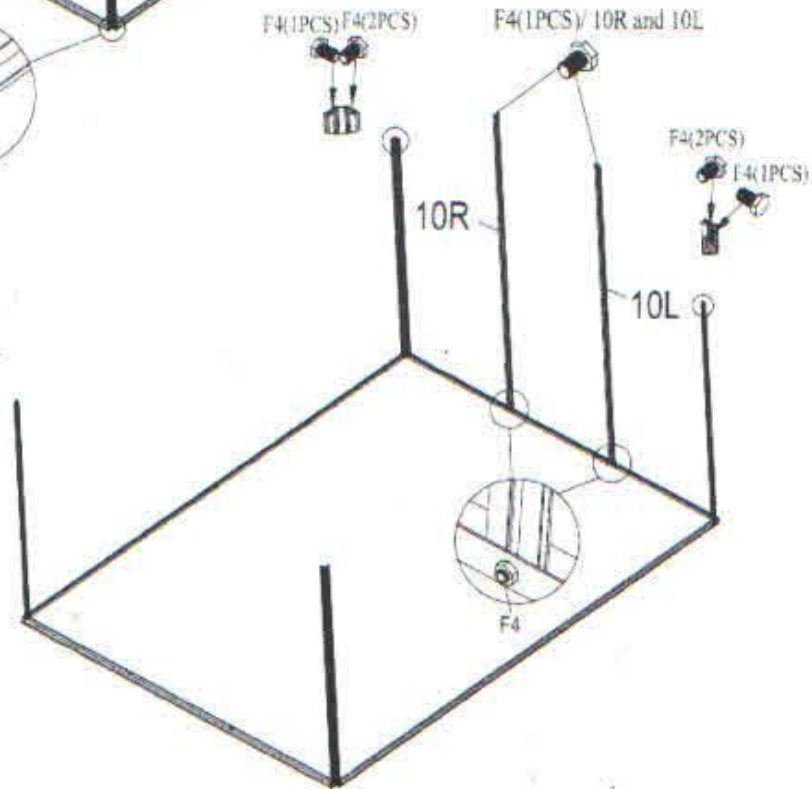

F4(2PCS) F4(1PCS)

PART	NO.	Qty.
	7	4
	10R 10L	1 1
	F4	8

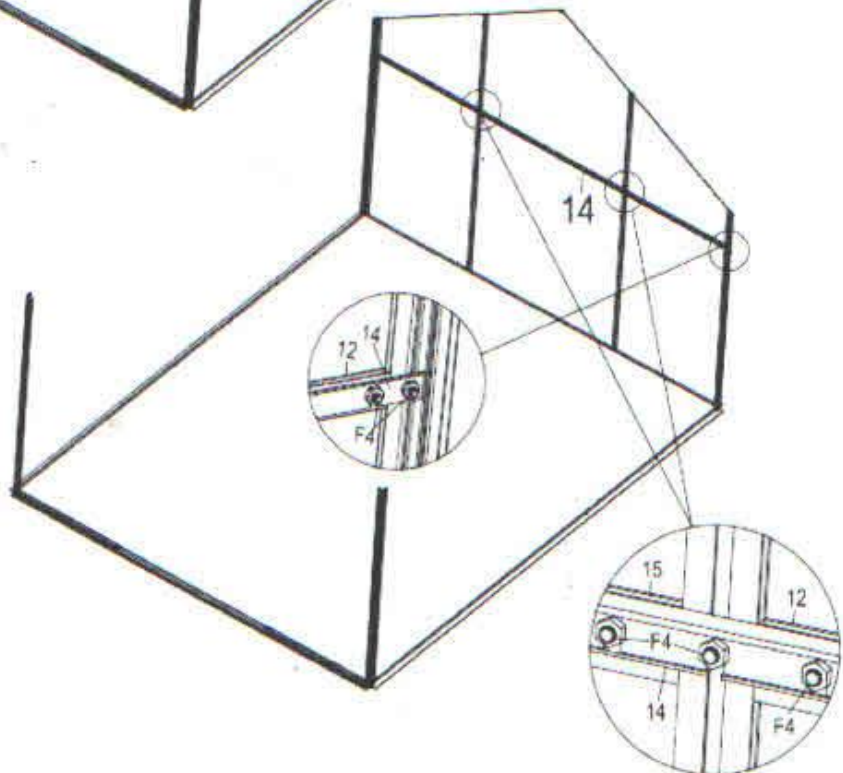
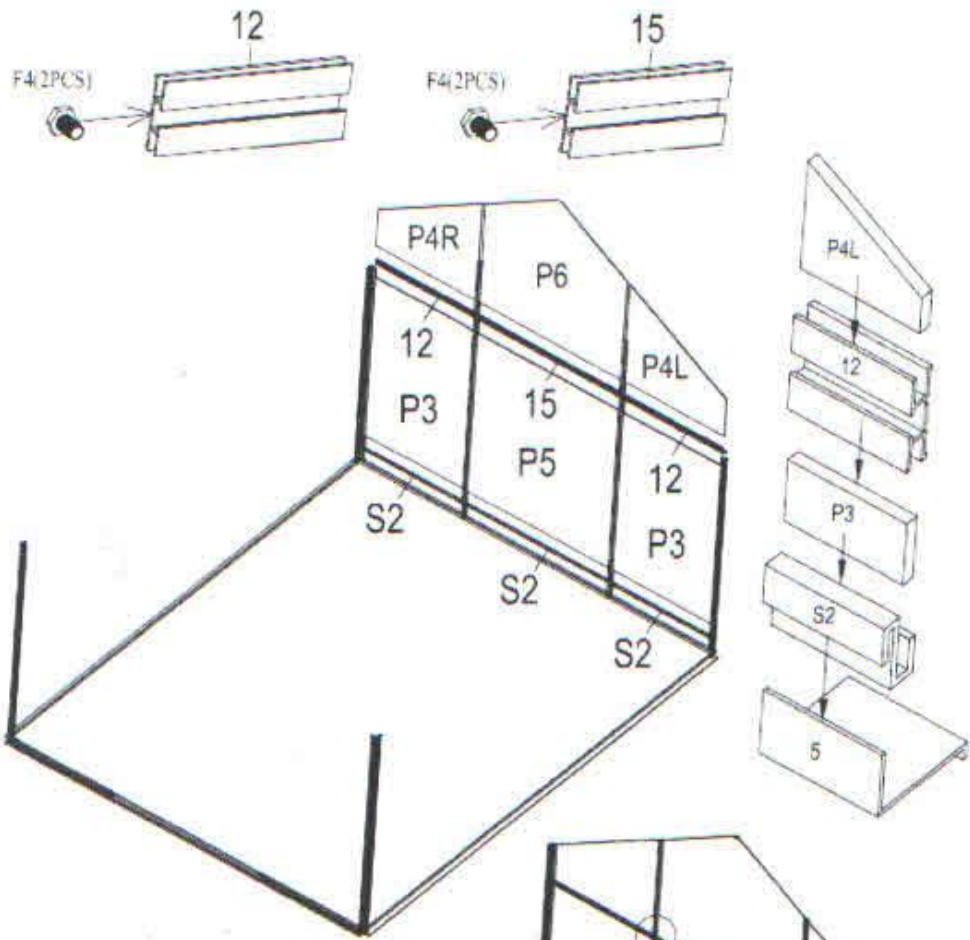







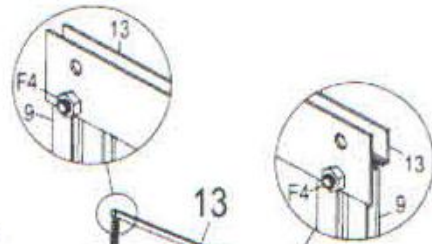
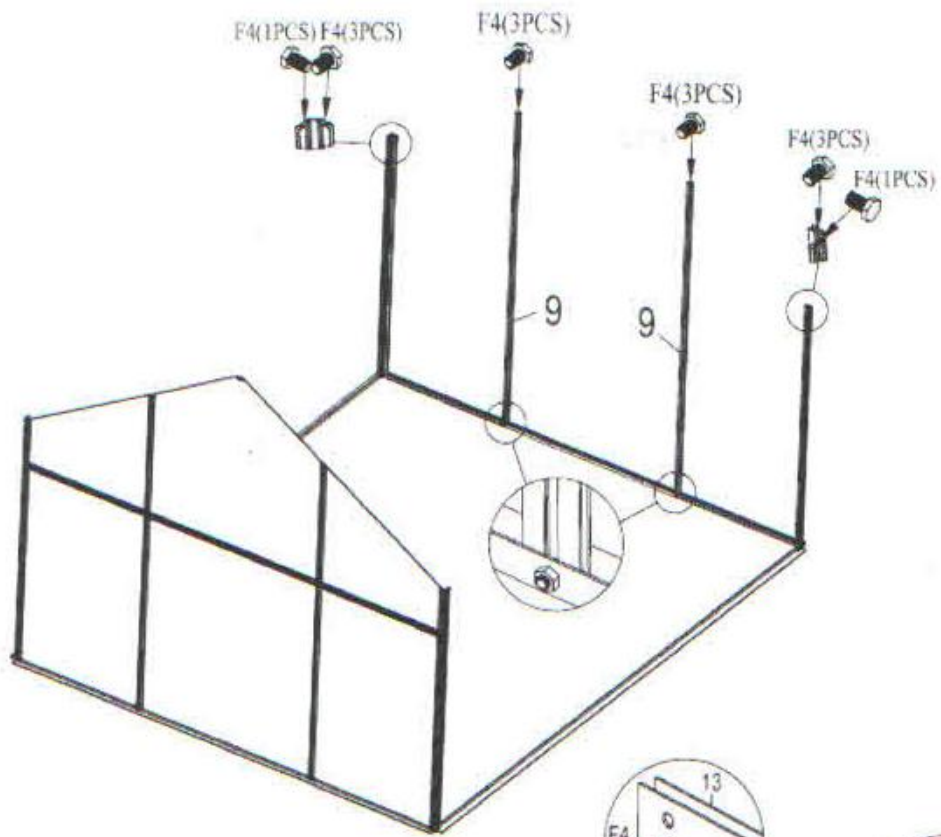

PART	NO.	Qty.
	S2	3
	12	2
	15	1
	14	1
	F4	6

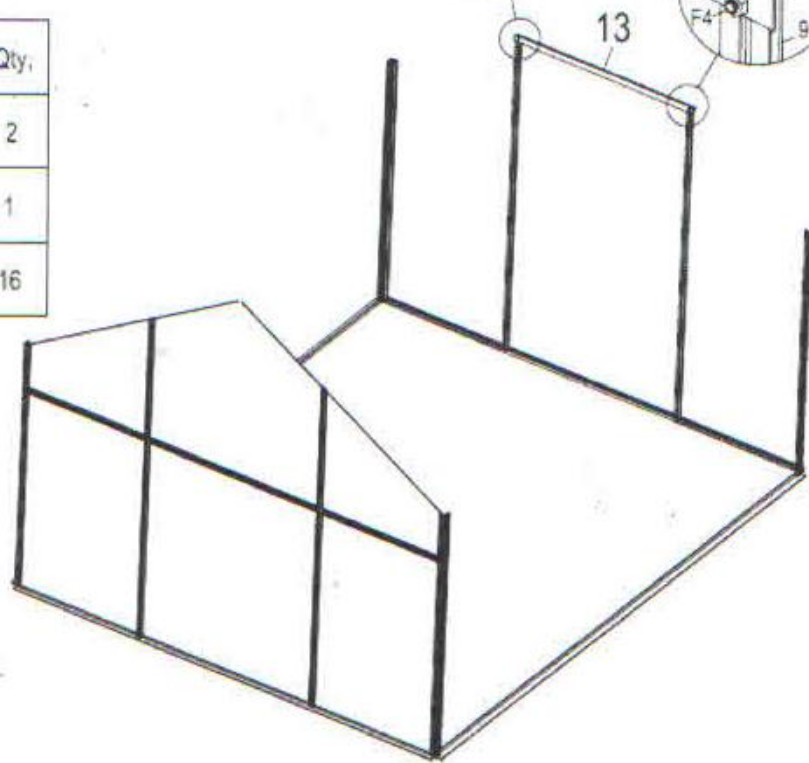

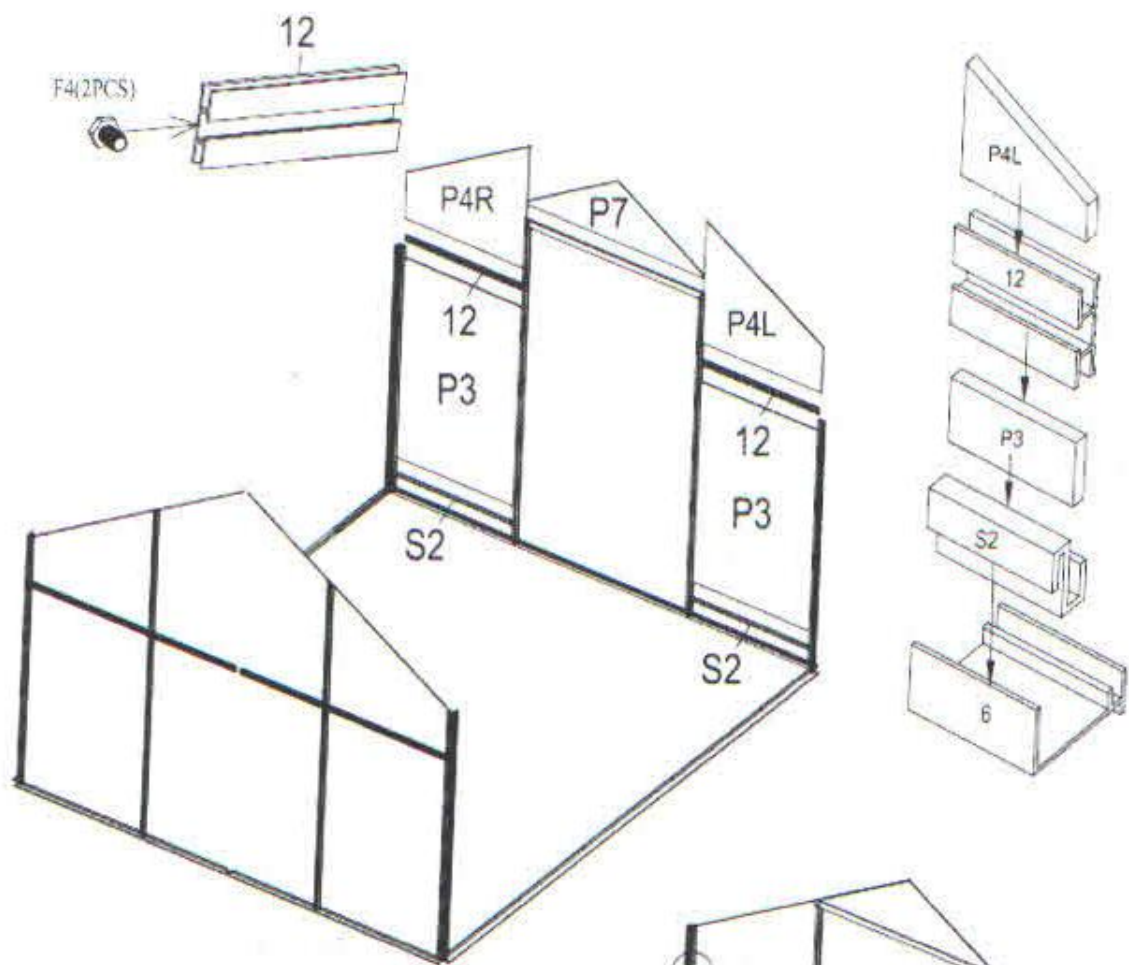
PART	NO.	Qty.
	9	2
	13	1
	F4	16





PART	NO.	Qty.
	S2	2
	12	2
	B1	4
	F4	4

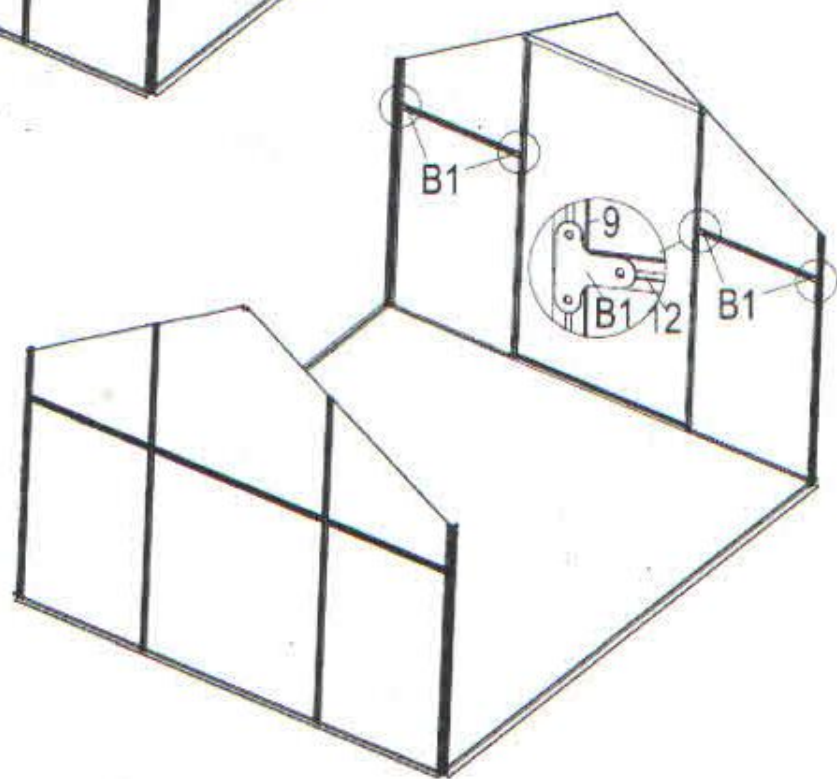

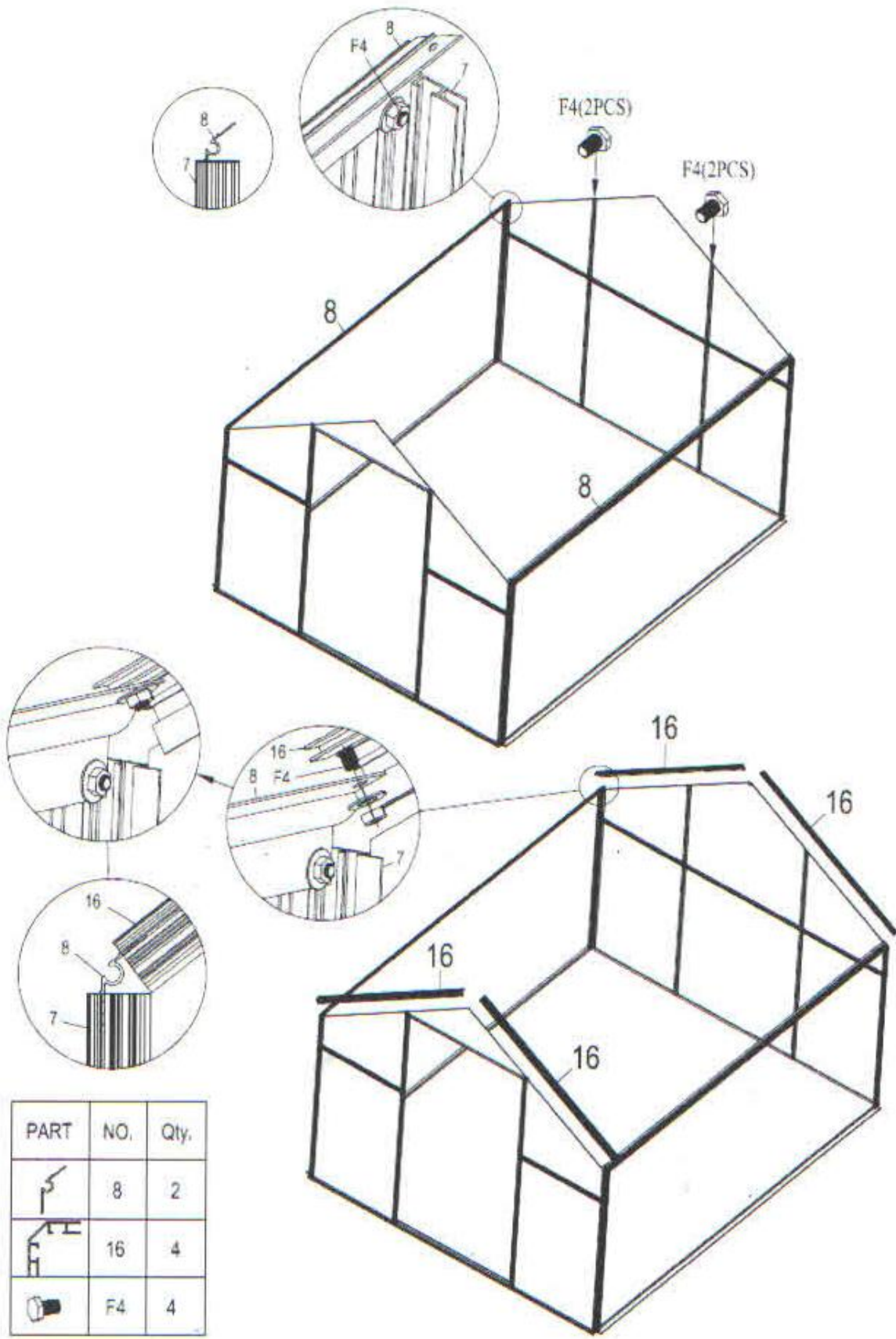





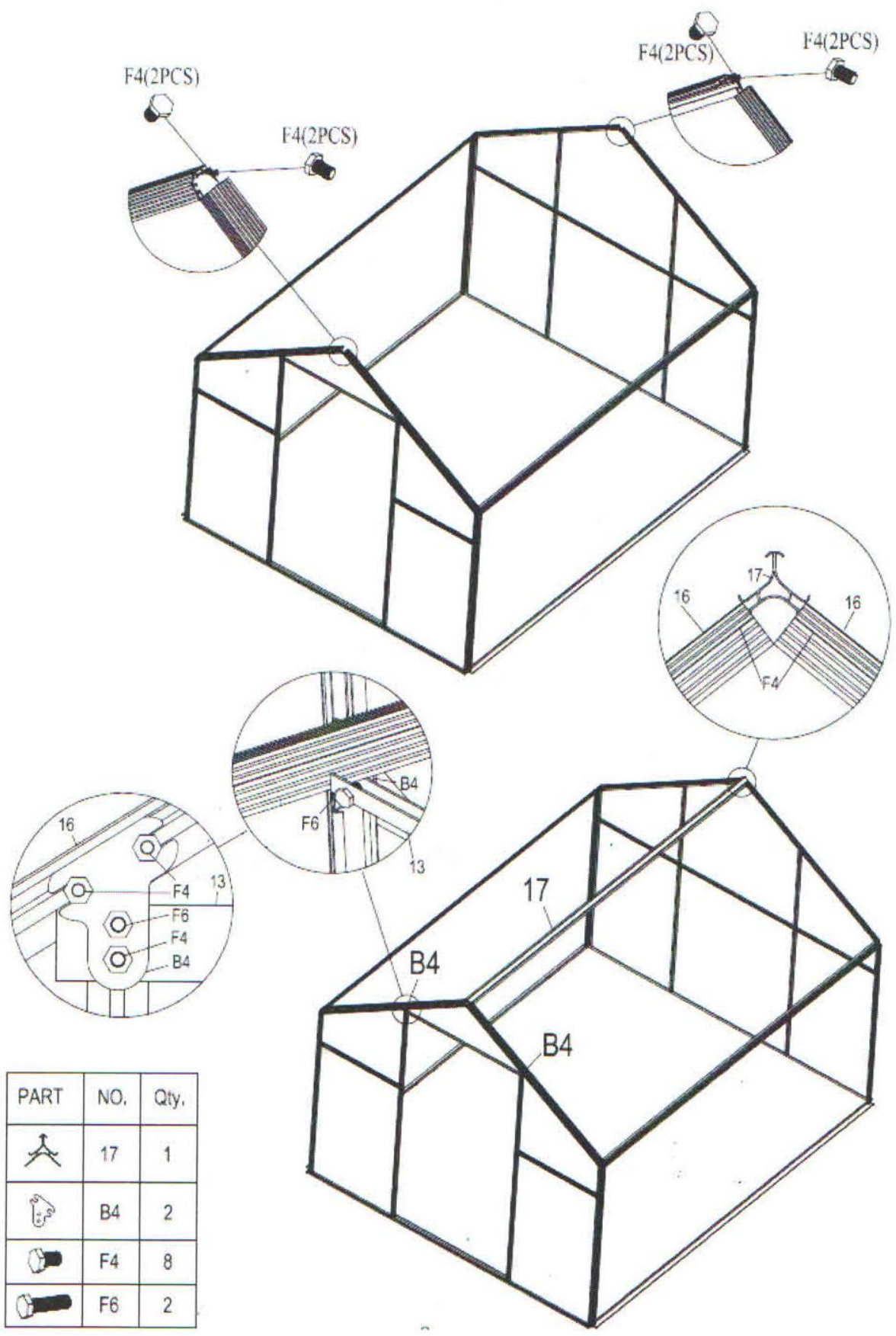





PART	NO.	Qty.
	8	2
	16	4
	F4	4





PART	NO.	Qty.
	17	1
	B4	2
	F4	8
	F6	2



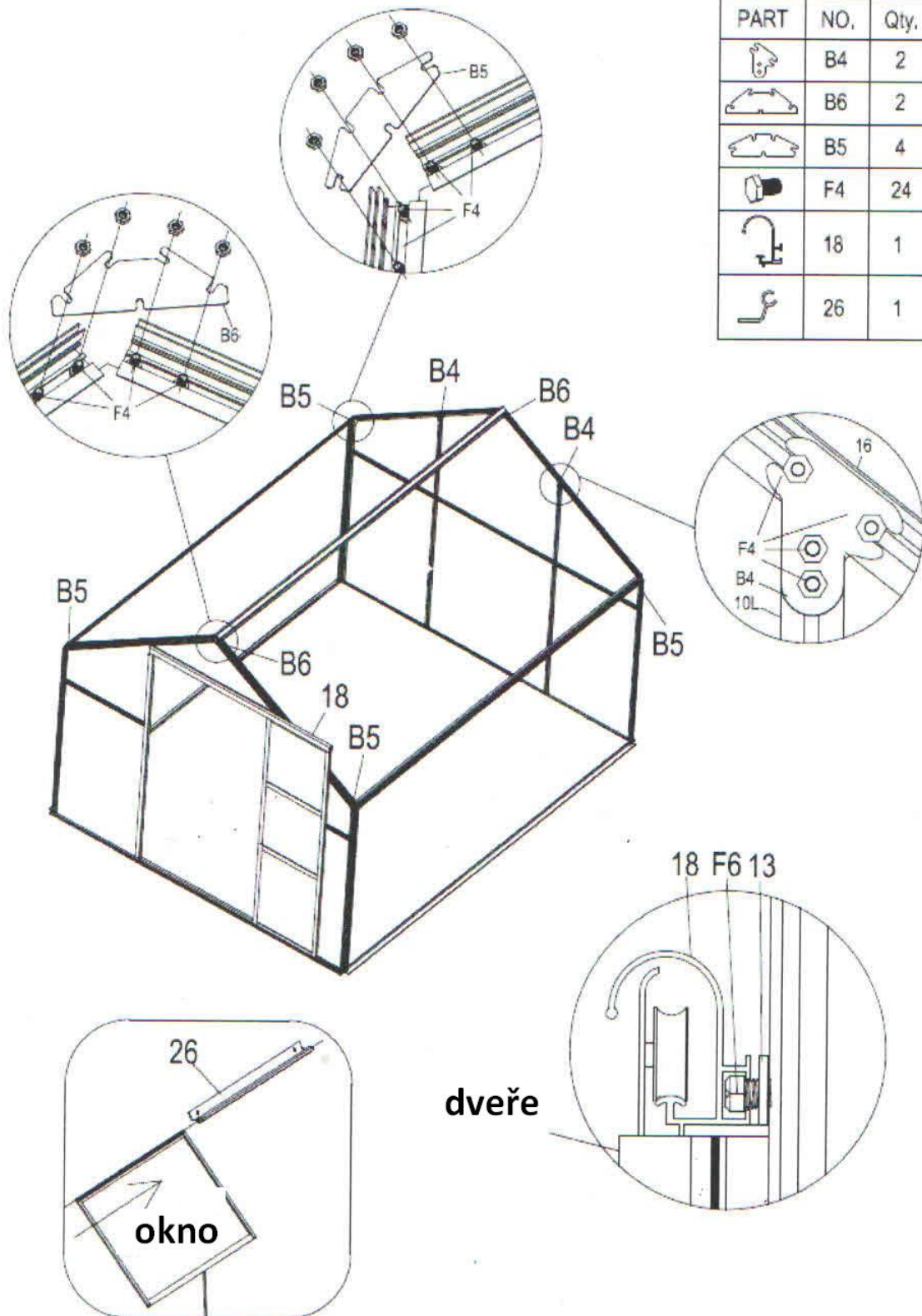

PART	NO.	Qty.
	B4	2
	B6	2
	B5	4
	F4	24
	18	1
	26	1

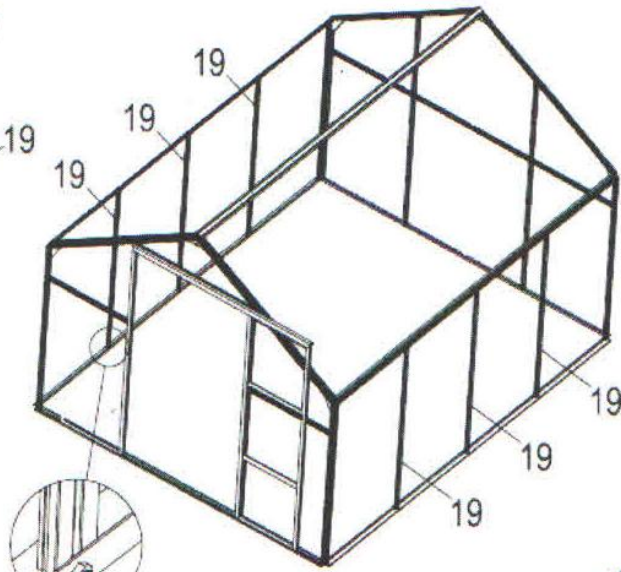

F4(2PCS)



PART	NO.	Qty.
	19	6
	20	6
	F4	28

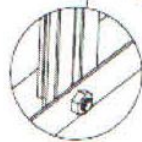

F4(4PCS)

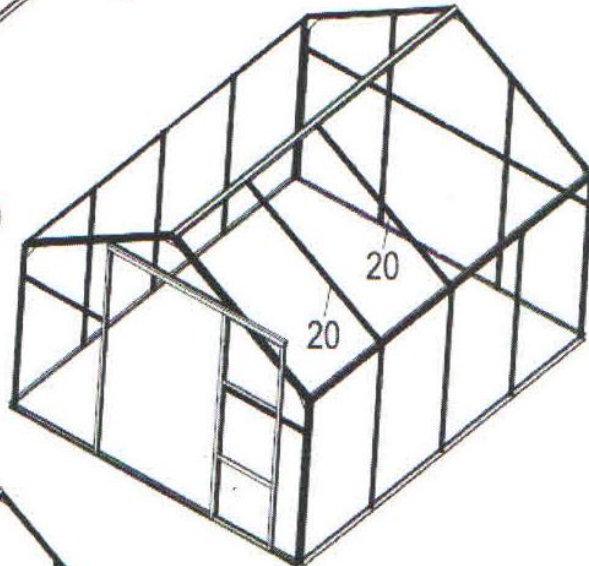
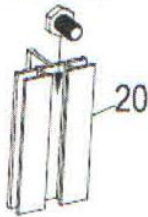

Poznámka: Prosím přidělte 4 šrouby v hliníkovém průřezu (20) vedle okna. Ve druhém hliníkovém průřezu (20) vyplňte 3 šrouby.

F4(2PCS)

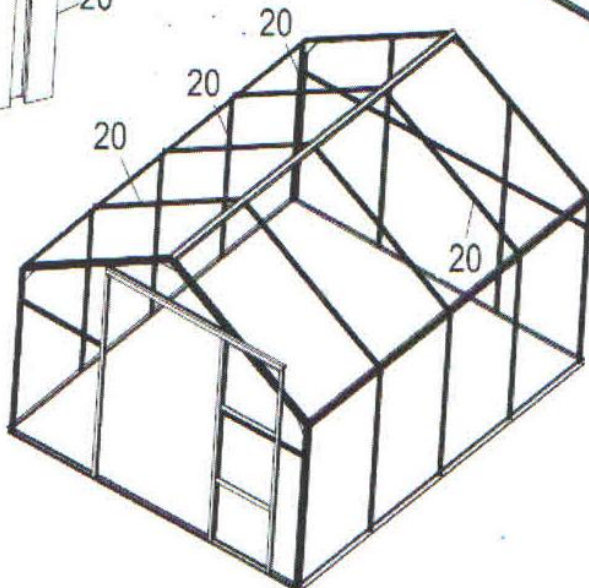
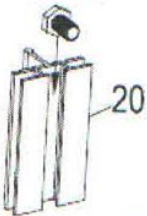

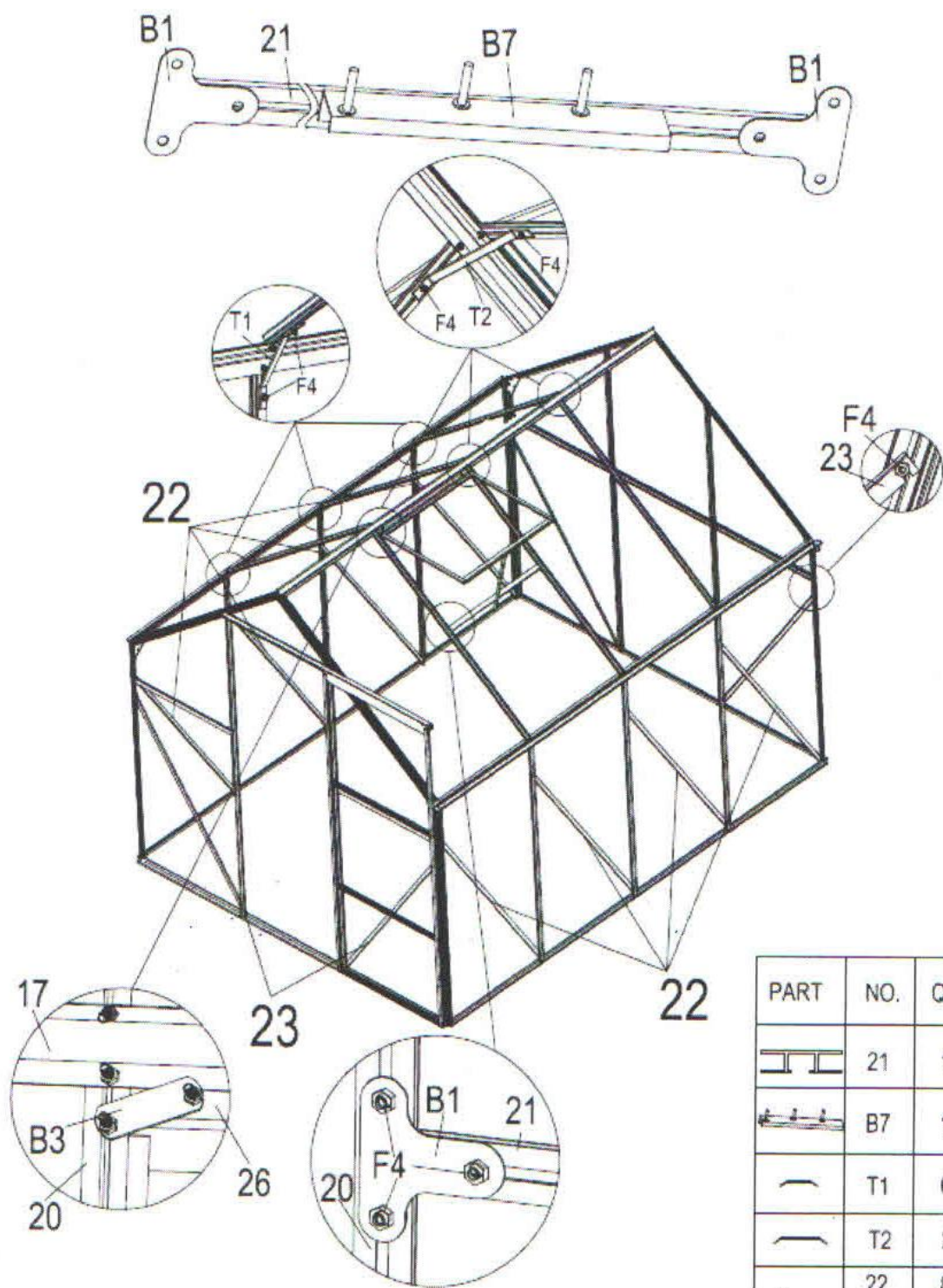





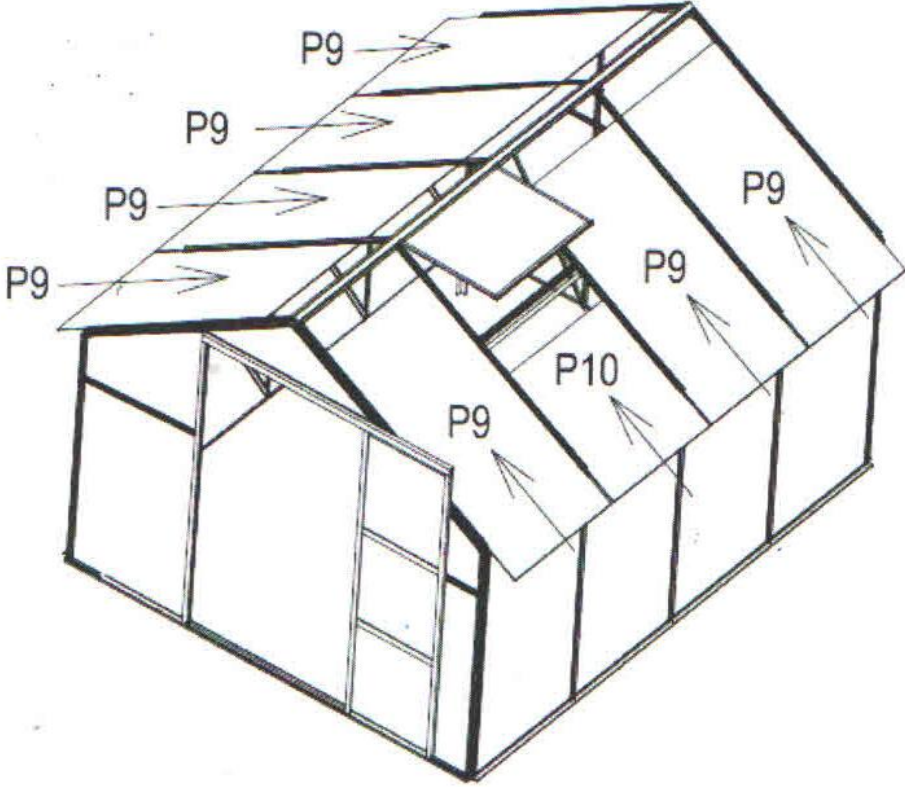
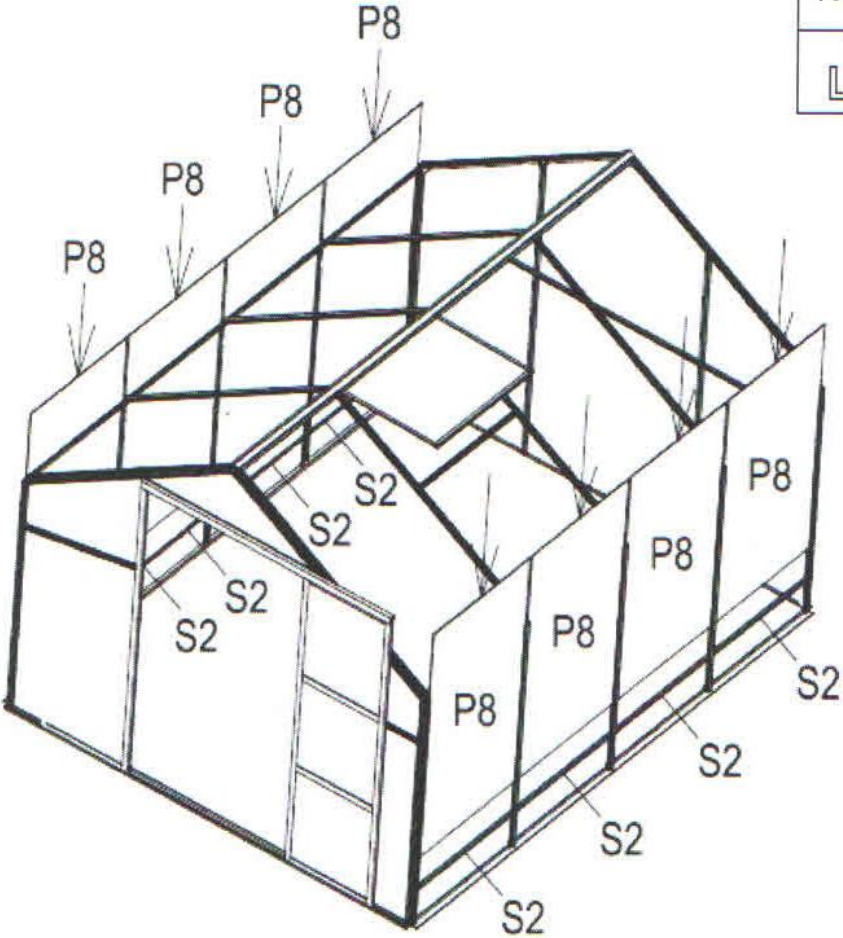

PART	NO.	Qty.
	21	1
	B7	1
	T1	6
	T2	3
	22	8
	23	4
	B1	2
	B3	2
	F4	6

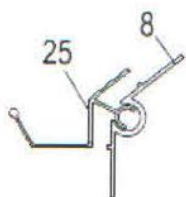

PART	NO.	Qty.
	S2	8





PART	NO.	Qty.
	25	2
	S5	2
	S6L	2
	S6R	2
	S7L	1
	S7R	1

