







# **MONTÁŽNÍ NÁVOD**

Výrobek č. M01274 Stojan na reproduktory

## **Seznam dílů:**

<b>číslo</b>	<b>jméno</b>	<b>popis</b>	<b>zobrazení</b>	<b>množství</b>
1	G	skleněná základna		1X2=2
2	nálepka	nohy (4 ks náhradní)		10
3	T	trubka/72 cm		1X2=2
4	A-S	hliníková deska		1X2=2
5	S	šrouby		2X2=4
6	S-C	krytí šroubů		2X1=2
7	S-A	samolepící proužky		2X2=4
8	TOOL	nářadí		1

## MONTÁŽNÍ NÁVOD

Výrobek č. M01274 Stojan na reproduktory

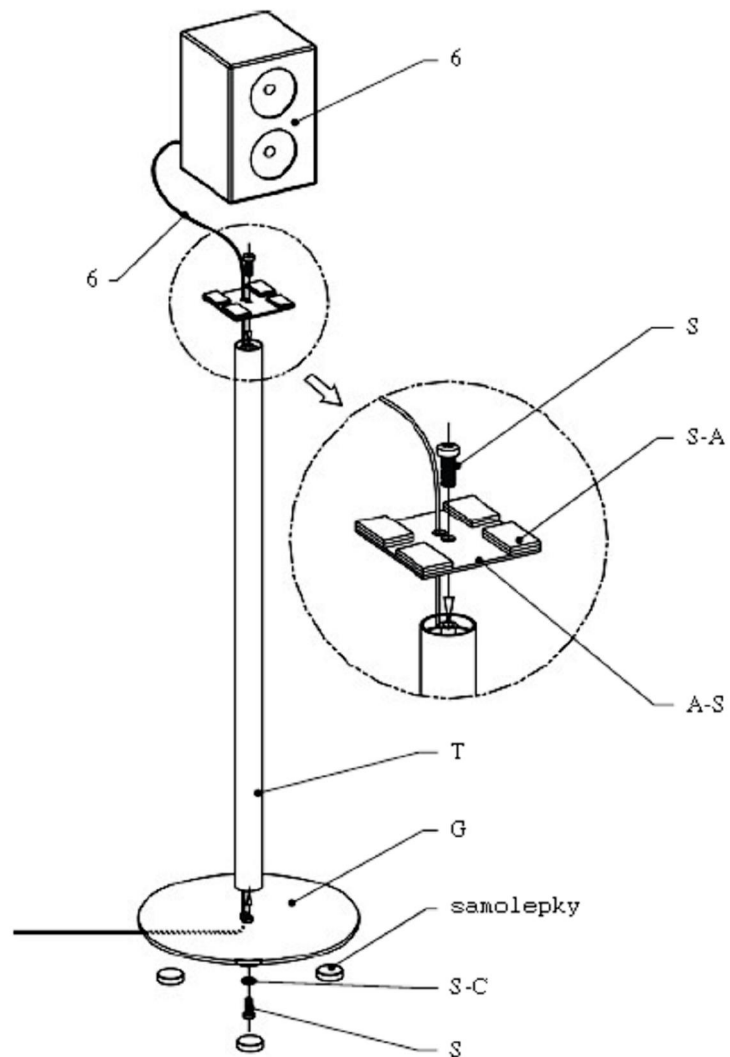

Montážní návod k výrobku: M01274

# **MONTÁŽNÍ NÁVOD**

Výrobek č. M01274 Stojan na reproduktory

